



SESSIONS

ALWAYS HAVE ALWAYS WILL

WINTER 2023 / 2024





SESSIONS

SKATEBOARDING & MUSIC HAVE ALWAYS BEEN A HUGE PART OF MY LIFE. THEY NOT ONLY SHAPED WHO I AM, THEY ALSO SHAPED SESSIONS AS A BRAND."
-FOUNDER, JOEL GOMEZ

IS SNOWBOARDING YOUR PASSION, A WAY OF LIFE, A...WAYS ON YOUR MIND? SAME WITH US. IT DOES NOT MATTER IF YOU ARE LAPPING 300 FEET OF VERTICAL WITH A ROPE TOW, SESSIONING YOUR SCHOOL'S HANDRAIL OR FLYING UP A MAJOR RESORT IN A HEATED GONDOLA- WE ARE HERE TO RIDE.

ALWAYS HAVE ALWAYS WILL

SESSIONS

ALWAYS



TEAM: FOR THE LOVE OF THE SPORT- OUR TEAM RIDES WITH CREATIVITY AND PASSION AND FUN. ON ANY GIVEN DAY YOU CAN FIND THE SESSIONS TEAM AT THE PARK OR IN THE STREETS MAKING THE MOST OF WHAT IS IN FRONT OF THEM.

SKATE



1984

Steve Caballero was the first Professional Skateboarder on to the Sessions Team
Corey O'Brien rides for the Sessions Skateboard Shop



1986

Sessions Mail order business starts selling skateboards



1987

Ray Barbee rides for the Sessions Team



Sessions snowboard shop team grows: Sean Palmer

1990

Salman Agah and Tim Brauch ride for Sessions



1993

Matt Hensley worked and rode for the Sessions Skateboard Shop in Chicago and rode for the Sessions Skateboard Shop



1994

John Cardiel Signature pants are released

1996

Sessions Launches ESTE, with Salman Agah and Tim Brauch (RIP)



Sessions snowboard shop is the first registered snowboard shop in the U.S.

1983

1984

Sessions snowboard shop first Pro Rider Terry Kidwell

1986

Sessions Mail order business starts selling snowboards

1987

1990

Sessions begins to make outerwear

1994

Sessions Jamie Lynn signature Jacket

1996

Sessions introduces Gore-Tex to the outerwear line

1999

Sessions release movie: Viva Sessions

SNOW

MUSIC

Sessions Mail order business starts Selling punk rock t-shirts and records

1986



Sessions Record Label is launched. Foot Fighters record and Descendents

1993



No Use For A Name / Soda, 7"

1996



Descendents Gotta (7" Single)
Gwar, Penguin Attack (7" Single)

1997



Supersuckers Hal Karate: 2 Coastin Classics' 7"

1999

ALWAYS HAVE ALWAYS WILL



2000's

Darren Navarrette, Corey Duffel, Scott Bourne, Chet Childress, Adam Aitara, J.R. Neves, Charlie Wilkins, Joe Hutchinson, Alex Chalmers, Austin Stevens, Jon Ponto, Josh Perkins



2020

Aaron "Jaws" Hemoki, Tristan Rennie, Chris Gregson

THE HISTORY OF



SESSIONS

Shane McConkey (RIP) signature jacket released

2001

Foo Fighters All My Life 7" Single

Steve Caballero Bandology Vol. 1 (CD, Comp)

2002



Sessions is the first snowboard brand to incorporate Recco into its garments

2006

Audioslave Show Me How To Live (7" Single, Red)

2003



Metallica / Sessions Jacket collaboration

2010



Pearl Jam / Sessions Jacket collaboration

2011



Jesse Paul rides for Sessions

2016



Metallica / Sessions 2nd Jacket collaboration

2017



Led Zeppelin / Sessions Outerwear collaboration

2020

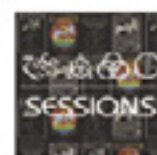

Sessions has always represented the passion for doing things on a board. The clothes, the music, and the life style. That will never change from now on. Go out and get some!

BEGINNING AS THE FIRST SNOWBOARD SHOP IN NORTH AMERICA, SESSIONS STANDS PROUDLY AS AN INFLUENCER OF SNOWBOARDING'S COUNTER CULTURE AND INNOVATOR OF BAR NONE OUTERWEAR. NOW, WITH 37+ YEARS OF HERITAGE, OUR BRAND STILL ADVOCATES FOR BOHEMIAN LIFESTYLE WHILE PRODUCING EXCEPTIONAL WINTER APPAREL. INSPIRED BY MUSIC, SKATEBOARDING AND SNOWBOARDING, WE ARE QUICK TO INVITE ANYONE WITH THE LOVE OF STANDING SIDWAYS TO BE A PART OF THE MOVEMENT - A MOVEMENT MUCH MORE THAN JUST BOARDING. SURE, WE LOVE FIRST CHAIRS, APRESKI AND ALL THE TALL TALES SHARED BEFORE AND AFTER RIPPING, BUT WHAT WE BELIEVE IN IS LIVING PASSIONATELY. SO, BALANCED SOMEWHERE IN-BETWEEN SKATE GRINDS AND THE 9 TO 5 GRIND, SESSIONS HAS BEEN AND WILL INDEFINITELY CONTINUE TO BE ABOUT SESSIONING LIFE...

JACKETS



OUR MISSION IS TO PROVIDE THE SESSIONS CUSTOMER WITH A WARM, DRY AND STYLISH PRODUCT TO GO OUT IN ALL CONDITIONS AND HAVE FUN.

ALWAYS HAVE ALWAYS WILL

SCOPE SHELL JACKET

THE FUTURE MEETS THE PAST WITH CLASSIC STYLING BUT ALL THE CURRENT FEATURES YOU NEED TO HELP MAKE YOUR DAY IN THE SNOW THE BEST IT CAN BE.



PURPLE
SSF230001

ORANGE
SSF230001

BEIGE
SSF230001

BLACK
SSF230001

FEATURES

- CRITICALLY SEAM-SEALED
- ADJUSTABLE 3-PIECE HOOD
- MESH BACKED UNDERARM VENTILATION
- YKK® AQUAGUARD® ZIPPERS
- AUDIO ROUTING
- JACKET TO PANT CONNECT
- LYCRA WRIST GAITERS
- STRETCH POWDER SKIRT
- INTERIOR GOGGLE POCKET
- SLEEVE PASS POCKET
- EASY ADJUST HEM W/ HAND POCKET ACCESS
- CUFF ADJUSTMENT W/EXTENSIONS
- BRUSHED TRICOT CHIN GUARD



LYCRA WRIST GAITER



JACKET TO PANT
CONNECT



UNDERARM
VENTILATION



SLEEVE PASS
POCKET



INTERIOR GOGGLE
POCKET



AUDIO ROUTING

FABRIC

- 2L CORE
- 2L RIP STOP
- LINING - BRUSHED TRICOT /
EMBOSSED TAFFETA / LYCRA / MESH

FIT

- STANDARD WITH DROPTAIL



SIZES

- XS - 2XL

WATERPROOF

- 10K / 10K

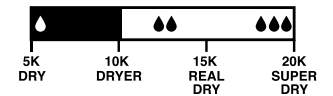

INSULATION

- SHELL

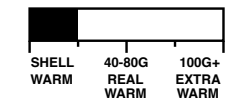

ALWAYS HAVE ALWAYS WILL

AGENT ANORACK PULLOVER JACKET

A RIDER FAVORITE, THE AGENT PULLOVER ANSWERS THE QUESTION- WHAT DO YOU GET WHEN YOU MIX EQUAL PARTS DRIP, FUNCTION AND COMFORT?



BLACK
SSF230002

YELLOW
SSF230002

OLIVE
SSF230002

BEIGE
SSF230002

FEATURES

- CRITICALLY SEAM-SEALED
- ADJUSTABLE 3-PIECE HOOD
- SIDE ZIP ENTRY
- MESH BACKED UNDERARM VENTILATION
- CONTRAST YKK® VISLON ZIPPERS
- LYCRA WRIST GAITERS
- POWDER SKIRT
- SLEEVE PASS POCKET
- EASY ADJUST HEM
- CUFF ADJUSTMENT W/EXTENSION
- AUDIO ROUTING
- BRUSHED TRICOT CHIN GUARD



SLEEVE PASS
POCKET



UNDERARM
VENTILATION



LYCRA WRIST
GAITERS



SIDE ZIP ENTRY



JACKET TO PANT
CONNECT



CUFF ADJUSTMENT
W/ EXTENSION

FABRIC

- 2L CORE
- LINING - BRUSHED TRICOT /
EMBOSSED TAFFETA / LYCRA / MESH

FIT

- STANDARD WITH DROPTAIL



SIZES

- XS - 2XL

WATERPROOF

- 10K / 10K

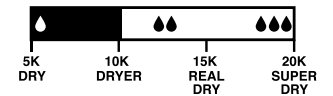

INSULATION

- 60 GM

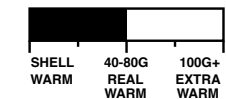

ALWAYS HAVE ALWAYS WILL

RECON SHELL JACKET

THE RECON JACKET DESIGN IS INSPIRED BY CLASSIC TRACK JACKETS BUT USES ALL THE IMPORTANT MATERIALS AND FEATURES TO KEEP YOU DRY AND WARM. SO WHEN YOU WANT TO LOOK SPORTY AND FRESH AND AVOID WEARING A WET RAG- STEP UP TO THE RECON.



BEIGE
SSFW230003

BRICK RED
SSFW230003

INDIGO
SSFW230003

PINK
SSFW230003

BLACK
SSFW230003

FEATURES

- CRITICALLY SEAM-SEALED
- ADJUSTABLE 3-PIECE HOOD
- MESH BACKED UNDERARM VENTILATION
- AUDIO ROUTING
- JACKET TO PANT CONNECT
- LYCRA WRIST GAITERS
- STRETCH POWDER SKIRT
- INTERIOR GOGGLE POCKET
- SLEEVE PASS POCKET
- EASY ADJUST HEM W/ HAND POCKET ACCESS
- CUFF ADJUSTMENT W/EXTENSIONS
- BRUSHED TRICOT CHIN GUARD



SLEEVE PASS
POCKET



UNDERARM
VENTILATION



LYCRA WRIST
GAITERS



JACKET TO PANT
CONNECT

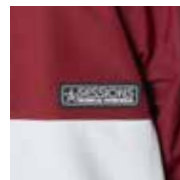

HIGH DENSITY
RUBBER LABEL



INTERIOR GOGGLE
POCKET

FABRIC

- 2L CORE
- LINING - EMBOSSED TAFFETA / BRUSHED TRICOT / LYCRA / MESH

FIT

- STANDARD WITH DROPTAIL



SIZES

- XS - 2XL

WATERPROOF

- 10K / 10K

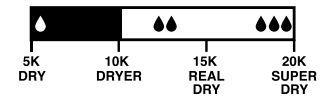

INSULATION

- SHELL

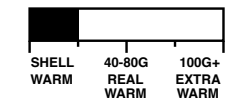

ALWAYS HAVE ALWAYS WILL

SCOUT INSUALTED JACKET

SOME PEOPLE ARGUE THAT BEST DAYS OF SNOWBOARDING WERE IN THE MID 90'S. WE DO NOT DISAGREE. AND IF YOU WANT TO RELIVE THAT SPECIAL PERIOD WITH A THROWBACK DESIGN BUT WITH ALL THE ADVANCES IN TECHNOLOGY THE LAST 25 YEARS HAS PROVIDED THEN THE SCOUT JACKET IS FOR YOU.



NAVY
SSF230005

BEIGE
SSF230005

INDIGO
SSF230005

BLACK
SSF230005

FEATURES

- CRITICALLY SEAM-SEALED
- ADJUSTABLE 3-PIECE HOOD
- MESH BACKED UNDERARM VENTILATION
- AUDIO ROUTING
- JACKET TO PANT CONNECT
- LYCRA WRIST GAITERS
- STRETCH POWDER SKIRT
- INTERIOR GOGGLE POCKET
- SLEEVE PASS POCKET
- EASY ADJUST HEM W/ HAND POCKET ACCESS
- CUFF ADJUSTMENT W/EXTENSIONS
- BRUSHED TRICOT CHIN GUARD

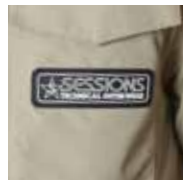

HIGH DENSITY
RUBBER LABEL



UNDERARM
VENTILATION



LYCRA WRIST
GAITERS



SLEEVE PASS
POCKET



JACKET TO PANT
CONNECT



CUFF ADJUSTMENT

FABRIC

- 2L CORE
- LINING - EMBOSSED TAFFETA / BRUSHED TRICOT / LYCRA / MESH

FIT

- STANDARD



SIZES

- XS - 2XL

WATERPROOF

- 10K / 10K

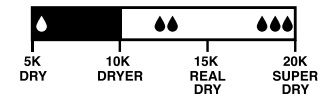

INSULATION

- 80 GM - BODY
- 60 GM - HOOD / SLEEVE

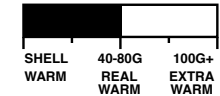

ALWAYS HAVE ALWAYS WILL

CHAOS PULLOVER JACKET

THE CHAOS JACKET HAS BEEN SESSIONS BEST SELLING JACKET FOR THE PAST FEW YEARS AND IT IS EASY TO SEE WHY- FUN DESIGN, GREAT FIT, A COLOR FOR EVERY TASTE AND STYLE CRED. THIS JACKET WILL NOT LET YOU DOWN.



NAVY
SSF230013



BLACK
SSF230013



WHITE
SSF230013



PINK
SSF230013



PURPLE
SSF230013



BEIGE
SSF230013



OLIVE
SSF230013



INDIGO
SSF230013

FEATURES

- CRITICALLY SEAM-SEALED
- ADJUSTABLE 3-PIECE HOOD
- MESH BACKED UNDERARM VENTILATION
- JACKET TO PANT CONNECT
- LYCRA WRIST GAITERS
- STRETCH POWDER SKIRT
- SLEEVE PASS POCKET
- EASY ADJUST HEM W
- CUFF ADJUSTMENT W/EXTENSIONS
- BRUSHED TRICOT CHIN GUARD
- DUAL TOP LOAD POCKETS
- ZIPPER ENTRY KANGAROO HAND POCKETS



SIDE ZIP ENTRY



TOP LOAD POCKETS
AND ZIPPER HAND
POCKETS



HALF ZIP WITH
VELCRO CLOSURE



JACKET TO PANT
CONNECT



CUFF ADJUSTMENT



LYCRA WRIST
GAITORS

FABRIC

- 2L CORE
- LINING - EMBOSSED TAFFETA / STRETCH LYCRA / MESH

FIT

- STANDARD



SIZES

- XS - 2XL

WATERPROOF

- 10K / 10K

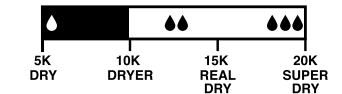

INSULATION

- 40 GM

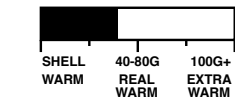

ALWAYS HAVE ALWAYS WILL

VITAL JACKET

THE VITAL JACKET IS A GREAT EXAMPLE OF KISS- KEEP IT SIMPLE SNOWBOARDER. YOU GET THE KEY ELEMENTS TO KEEP YOU WARM AND DRY WRAPPED UP IN A CLASSIC DESIGN THAT DOES NOT GO OUT OF STYLE.



BLACK
SSF230024



ORANGE
SSF230024



BRICK RED
SSF230024



FEATURES

- CRITICALLY SEAM-SEALED
- ADJUSTABLE HOOD
- AUDIO ROUTING
- MESH BACKED UNDERARM VENTILATION
- JACKET TO PANT CONNECT
- POWDER SKIRT
- INTERIOR GOGGLE POCKET
- ZIPPER HAND POCKETS
- CUFF ADJUSTMENT W/EXTENSIONS
- BRUSHED TRICOT CHIN GUARD



LOGO SCREEN PRINT



ZIPPER HAND POCKETS



UNDERARM VENTILATION



CUFF ADJUSTMENT W/ EXTENSIONS



JACKET TO PANT CONNECT



LYCRA WRIST GAITORS

FABRIC

- 2L CORE
- LINING - BRUSHED TRICOT / TAFFETA / MESH

FIT

- STANDARD



SIZES

- XS - 2XL

WATERPROOF

- 10K / 8K

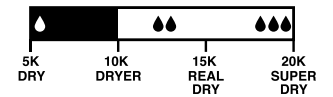

INSULATION

- SHELL

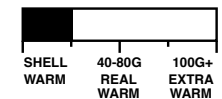

ALWAYS HAVE ALWAYS WILL

PANTS



SESSIONS HAS PANTS FOR EVERY OCCASION. WE HAVE PANTS FOR POWDER, PANTS FOR PARK LAPS, PANTS FOR PARK LAPS IN POWDER.

ALWAYS HAVE ALWAYS WILL

SIGNAL BIB

IF YOU DO NOT OWN A PAIR OF BIBS YET YOU SHOULD PROBABLY PICK THESE UP. THE SIGNAL BIB IS ROOMY FOR EASE OF MOVEMENT, KEEPS THE ELEMENTS OUT BETTER THAN REGULAR PANTS AND STYLE POINTS DUE TO ITS COOL DESIGN.



BLACK
SSFW230007



INDIGO
SSFW230007



OLIVE
SSFW230007



ORANGE
SSFW230007



ORANGE
SSFW230007

FEATURES

- CRITICALLY SEAM-SEALED
- ADJUSTABLE SHOULDER STRAPS
- CHEST POCKET
- MESH BACKED INSEAM VENTS
- E-ZEE PEE ACCESS
- 2 WAY CENTER FRONT ZIP
- SNAP HEM GUSSET
- CORDURA REINFORCED BACK HEM
- KNEE ARTICULATION
- BOOT GAITERS
- BOOT HOOKS



CHEST POCKET



2 WAY CENTER FRONT ZIPPER



INSEAM VENTS

FABRIC

- 2L CORE
- 2L RIP STOP
- LINING - BRUSHED TRICOT / EMBOSSED TAFFETA / MESH

FIT

- BAGGY



SIZES

- XS - 2XL

WATERPROOF

- 10K / 10K

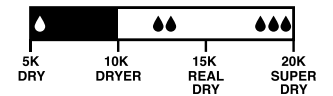

INSULATION

- 40 GM - SEAT / KNEE

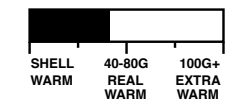

ALWAYS HAVE ALWAYS WILL

MAJOR CARGO PANT

WHY DO WE CALL THIS THE MAJOR PANT? MAJOR VOLUME, MAJOR STORAGE OPTIONS, MAJOR COMFORT, MAJOR DRIP. THAT'S WHY.



YELLOW
SSF230008

BEIGE
SSF230008

OLIVE
SSF230008

INDIGO
SSF230008

BLACK
SSF230008

FEATURES

- CRITICALLY SEAM-SEALED
- MESH BACKED INSEAM VENTS
- EXTERNAL WAIST ADJUSTMENT SYSTEM
- POWDER SKIRT INTERFACE
- SNAP HEM GUSSET
- CORDURA REINFORCED BACK HEM
- KNEE ARTICULATION
- CARGO POCKET
- GLOVE HOOK
- BOOT GAITERS
- BOOT HOOKS
- MULTI HOOK



GLOVE HOOK



POWDER SKIRT
INTERFACE



MESH BACKED
INSEAM VENTS



MULTI HOOK

FABRIC

- 2L CORE
- 2L RIP STOP
- LINING - BRUSHED TRICOT / EMBOSSED TAFFETA / MESH

FIT

- BAGGY



SIZES

- XS - 2XL

WATERPROOF

- 10K / 10K

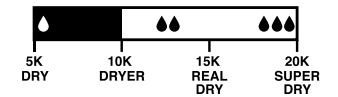

INSULATION

- 40 GM - SEAT / KNEE

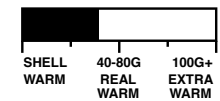

ALWAYS HAVE ALWAYS WILL

SQUADRON STANDARD FIT CARGO PANT

THIS PANT IS A PERFECTLY MODERN STANDARD FIT CARGO, REP YOUR STREET STYLE WHILE SHREDDING THE MOUNTAIN. THE SQUADRON DESIGN COMBINES COMFORT WITH STYLE.



WHITE
SSF230009

PINK
SSF230009

BRICK RED
SSF230009

PURPLE
SSF230009

NAVY
SSF230009

BLACK
SSF230009

OLIVE
SSF230009

BEIGE
SSF230009

FEATURES

- CRITICALLY SEAM-SEALED
- MESH BACKED INSEAM VENTS
- EXTERNAL WAIST ADJUSTMENT SYSTEM
- POWDER SKIRT INTERFACE
- SNAP HEM GUSSET
- CORDURA REINFORCED BACK HEM
- KNEE ARTICULATION
- BOOT GAITERS
- BOOT HOOKS



CARGO POCKETS



MESH BACKED
INSEAM VENTS



POWDER SKIRT
INTERFACE



MULTI HOOK

FABRIC

- 2L CORE
- LINING - EMBOSSED TAFFETA / BRUSHED TRICOT / MESH

FIT

- STANDARD



SIZES

- XS - 2XL

WATERPROOF

- 10K / 10K

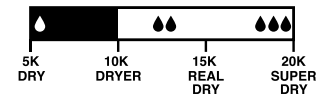

INSULATION

- 40 GM - SEAT / KNEE

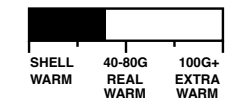

ALWAYS HAVE ALWAYS WILL

CAPITAL PANT

THE CAPITAL IS THE ULTIMATE IN LO-FI PANT DESIGN. STREAMLINED AND SIMPLE BUT KEEPS YOU DRY AND WARM.



NAVY
SSFW230025



BEIGE
SSFW230025



BLACK
SSFW230025

FEATURES

- CRITICALLY SEAM-SEALED
- MESH BACKED INSEAM VENTS
- EXTERNAL WAIST ADJUSTMENT SYSTEM
- POWDER SKIRT INTERFACE
- SNAP HEM GUSSET
- CORDURA REINFORCED BACK HEM
- KNEE ARTICULATION
- BOOT GAITERS
- BOOT HOOKS
- ZIPPER HAND POCKETS
- VELCRO SECURE BACK POCKET



POWDER SKIRT
INTERFACE



INSEAM VENTS

FABRIC

- 2L CORE
- LININ - TAFFETA / BRUSHED TRICOT / MESH

FIT

- STANDARD

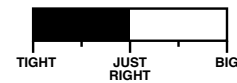

SIZES

- XS - 2XL

WATERPROOF

- 10K / 8K

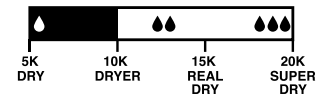

INSULATION

- SHELL

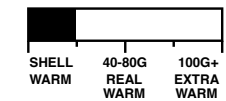

ALWAYS HAVE ALWAYS WILL

SESSIONS GLOVES & NECK HOODIE

FIVE FINGER GLOVES



THREE FINGER GLOVES

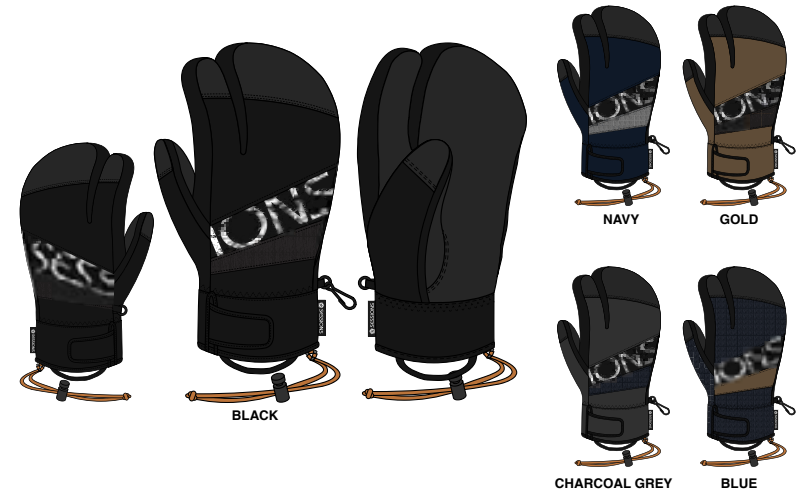

FIVE FINGER GLOVES



NECK HOODIE

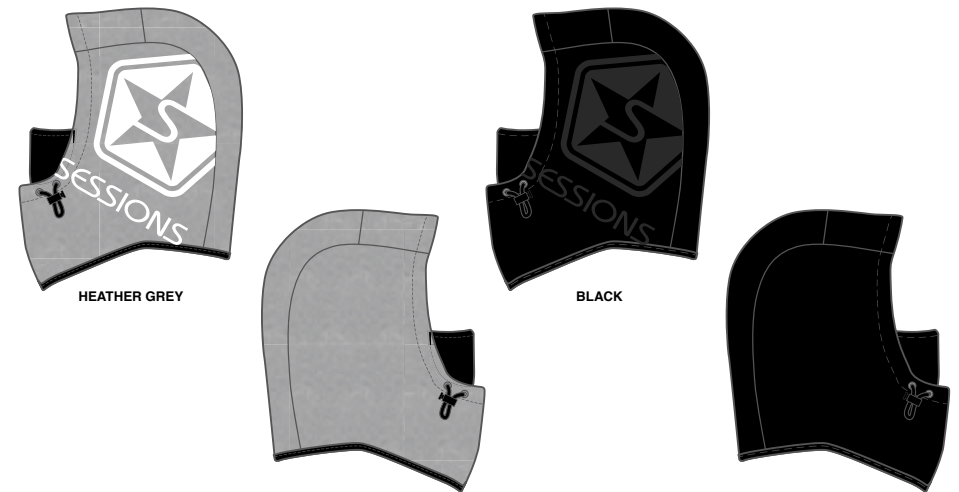

ALWAYS HAVE ALWAYS WILL

AWA



ALWAYS HAVE ALWAYS WILL

MISSION 1/4 ZIP HOOD

IF YOU LIKE A COZY FLEECE LINED PULL OVER THAT IS WATERPROOF AND LOOKS AS GOOD ON THE SNOW AS IT DOES IN THE STREETS THEN GET THIS AND MISSION COMPLETE.



OLIVE
SSFW230004

BLACK
SSFW230004

BEIGE
SSFW230004

NAVY
SSFW230004

PINK
SSFW230004

FEATURES

- CRITICALLY SEAM-SEALED
- ADJUSTABLE HOOD
- KANGAROO POCKET WITH ZIP CLOSURE
- SLEEVE RIB CUFF ADJUSTMENT W/EXTENSIONS
- ELASTIC GRIPPER HEM



KANGAROO POCKET
W/ ZIP CLOSURE



CENTER FRONT
HALF ZIP



SLEEVE RIB AND
CUFF ADJUSTMENT

FABRIC

- 2L PONGEE
- LINING- BRUSHED TRICOT/
EMBOSSED TAFFETA / TAFFETA

FIT

- WIDE



SIZES

- XS - 2XL

WATERPROOF

- 10K / 10K

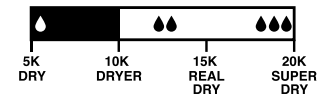

INSULATION

- SHELL

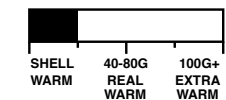

ALWAYS HAVE ALWAYS WILL

BRACKET JOGGER PANT

THE BRACKET HAS BECOME A TEAM FAVORITE. THE SOFTSHELL MATERIAL COMBINED WITH THE STREET FIT AND DESIGN ALLOWS YOU TO LOOK CASUAL BUT FEEL PERFORMANCE. z



BEIGE
SSFW230011



OLIVE
SSFW230011



PINK
SSFW230011



BLACK
SSFW230011

FEATURES

- CRITICALLY SEAM-SEALED
- INTERNAL WAIST ADJUSTMENT SYSTEM
- HAND POCKETS
- BACK POCKETS
- KNEE ARTICULATION
- ELASTIC GRIPPER HEM



EASY ADJUST BELT



GRIPPER HEM

FABRIC

- 2L PONGEE
- LINING- BRUSHED TRICOT/
EMBOSSD TAFFETA / TAFFETA

FIT

- SUPER BAGGY



SIZES

- XS - 2XL

WATERPROOF

- 10K / 10K

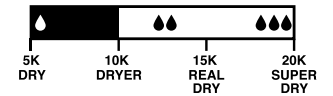

INSULATION

- SHELL

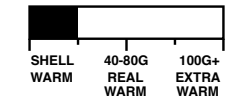

ALWAYS HAVE ALWAYS WILL

SHELTER FLEECE HOODIE



GREY
SE23F104PK



BLACK
SE23F104PK



WHITE
SE23F104PK

FEATURES

- RIBBED CUFFS W/ THUMB HOLE
- ZIPPER KANGAROO POCKET

FABRIC

- FLEECE

FIT

- STANDARD

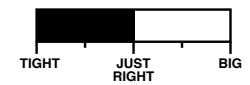

SIZES

- XS - 2XL

ALWAYS HAVE ALWAYS WILL

BANNER FLEECE CREW



GREY
SE23F103CN



BLACK
SE23F103CN



WHITE
SE23F103CN

FEATURES

- RIBBED CUFFS W/ THUMB HOLE
- ZIPPER KANGAROO POCKET

FABRIC

- FLEECE

FIT

- STANDARD

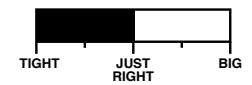

SIZES

- XS - 2XL

ALWAYS HAVE ALWAYS WILL

DENIM BOMBER JACKET
237186



IBLU

LBLU

DENIM BOBER PANTS
237187



IBLU

LBLU

PAISLEY BOX LONG TEE
237188



WHT

NVY

FLAG LONG TEE
237189



WHT

NVY

PAISLEY BOX HOODIE
237190



WHT

NVY

LINE HALF ZIP
237191



WHT

NVY

OUTERWEAR OVERVIEW

SCOPE SHELL JACKET



PURPLE
SSF230001

ORANGE
SSF230001

BEIGE
SSF230001

BLACK
SSF230001

AGENT ANORACK PULLOVER JACKET



BLACK
SSF230002

YELLOW
SSF230002

OLIVE
SSF230002

BEIGE
SSF230002

RECON JACKET



BEIGE
SSF230003

BRICK RED
SSF230003

INDIGO
SSF230003

PINK
SSF230003

BLACK
SSF230003

SCOUT INSULATED JACKET



NAVY
SSF230005

BEIGE
SSF230005

INDIGO
SSF230005

BLACK
SSF230005

CHAOS PULLOVER JACKET



NAVY
SSF230013

BLACK
SSF230013

WHITE
SSF230013

PINK
SSF230013

PURPLE
SSF230013

BEIGE
SSF230013

INDIGO
SSF230013

OLIVE
SSF230013

VITAL JACKET



BLACK
SSF230024

ORANGE
SSF230024

BRICK RED
SSF230024

SIGNAL BIB



BLACK
SSF230007

INDIGO
SSF230007

OLIVE
SSF230007

ORANGE
SSF230007

BEIGE
SSF230007

ALWAYS HAVE ALWAYS WILL

MAJOR CARGO PANT



YELLOW SSFW230008
BEIGE SSFW230008
OLIVE SSFW230008
INDIGO SSFW230008
BLACK SSFW230008

SQUADRON CARGO PANT



WHITE SSFW230009
PINK SSFW230009
BRICK RED SSFW230009
PURPLE SSFW230009
NAVY SSFW230009
OLIVE SSFW230009
BLACK SSFW230009
BEIGE SSFW230009

CAPITAL PANT



NAVY SSFW230025
BEIGE SSFW230025
BLACK SSFW230025

MISSION 1/4 ZIP HOOD 2L + LINER



OLIVE SSFW230004
BLACK SSFW230004
BEIGE SSFW230004
NAVY SSFW230004
PINK SSFW230004

BRACKET JOGGER PANT



BEIGE SSFW230011
OLIVE SSFW230011
PINK SSFW230011
BLACK SSFW230011

SHELTER FLEECE HOODIE



GREY SE23F104PK
BLACK SE23F104PK
WHITE SE23F104PK

BANNER FLEECE CREW



GREY SE23F103CN
BLACK SE23F103CN
WHITE SE23F103CN

ALWAYS HAVE ALWAYS WILL

HARDGOODS



"OH HELL YES! I'VE BEEN SNOWBOARDING SINCE 1980, TO SEE SESSIONS COMING OUT WITH THEIR FIRST SNOWBOARDS AFTER ALL THESE YEARS, ALL I CAN SAY IS I'M STOKED TO BE ABLE TO GO RIDE A SESSIONS SNOWBOARD - JOEL GOMEZ
-FOUNDER, JOEL GOMEZ

SESSIONS BEGAN AS THE ORIGINAL SKATE SHOP EMBEDDED IN THE HARDCORE NORTHERN CALIFORNIA SCENE. EQUAL PARTS SKATEBOARDING AND ROCK-N-ROLL, SESSIONS WAS SYNONYMOUS WITH THE BACKYARD RAMPS, PARKS, STREET SPOTS AND RIPPERS OF THE DAY. SESSIONS WAS THE FIRST BRAND TO MAKE THE SEAMLESS CONNECTION FROM SKATE AND MUSIC INTO SNOWBOARDING AND THIS LEGACY CONTINUES TIL THIS DAY. THIS IS WHO WE ARE, WHAT WE DO...

ALWAYS HAVE ALWAYS WILL

23/24 SESSIONS SNOWBOARD MATRIX DIAGRAM

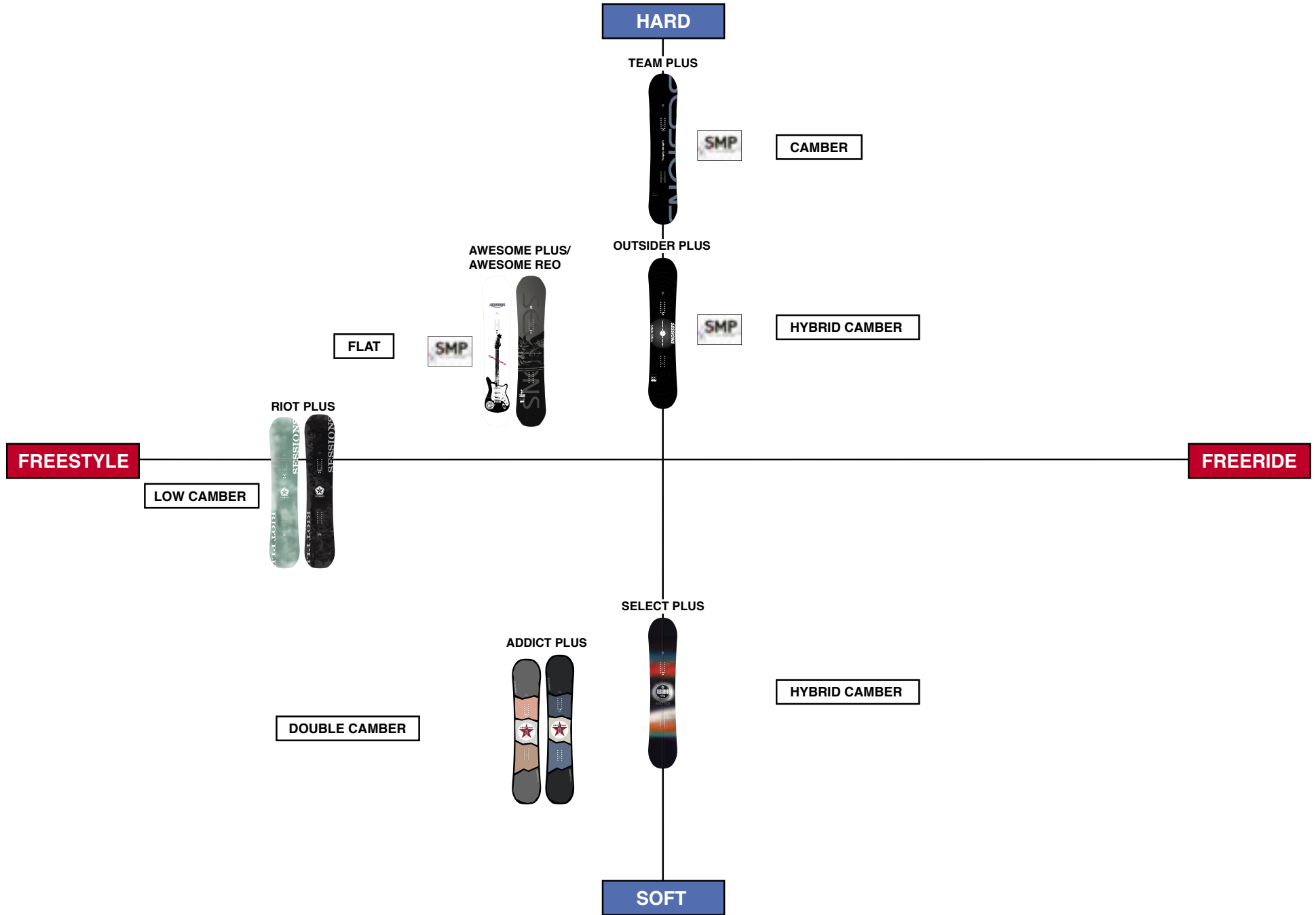

ALWAYS HAVE ALWAYS WILL

TEAM PLUS

THIS IS THE ULTIMATE CAMBER BOARD THAT YOU HAVE BEEN WAITING FOR. THE SIDE CUT HAS UNIQUE SHAPE UNDER THE BINDING AREAS, CALLED TEAM TRAC PODS, WHICH HELPS THE BOARD HOLD ITS EDGE ON HARD PACK WITHOUT INTERFERING WITH YOUR POWDER RUNS. THIS SPECIAL EXTRA EDGE MAKES SURE YOU STAY STABLE IN THOSE TURNS, AND ALSO PREVENTS YOU FROM SLIPPING OUT WHEN APPROACHING A KICKER LIP. UTILIZING A MESH CARBON SHEET IN TWO LAYERS MAKES THIS BOARD LIGHT, RESPONSIVE YET PLAYFUL, AND MAKES IT DIFFICULT TO LOOSEN A FIBERGLASS REINFORCEMENT PLATE IS USED UNDER THE BINDING AREA TO HELP STRENGTHEN THE BOARD ON THOSE STRESS AREAS IN LANDINGS AND DURING PRESS. SLOPESTYLE, HALF PIPE, GROUND TRICKS, AND CARVING, THIS IS A DO IT ALL AND DO IT WELL BOARD FOR THOSE WANTING THE BEST PERFORMANCE FROM THEIR BOARD.

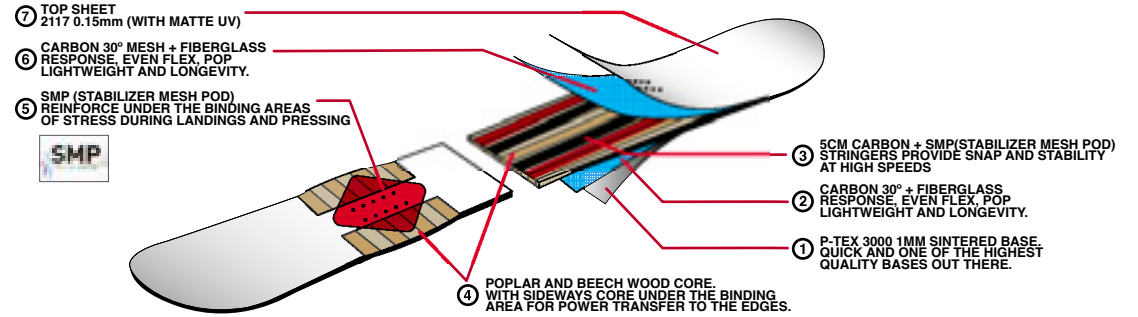

TWIN SHAPE:

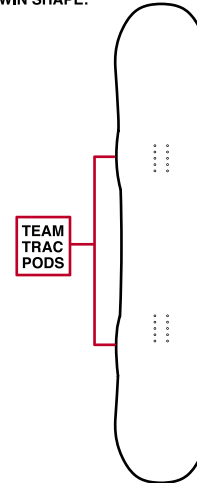

BASELINE:

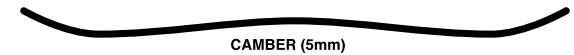

FLEX

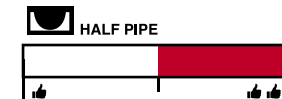
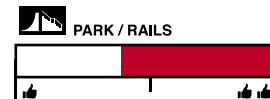

DIMENSIONS

SIZE	EFFECTIVE EDGE CM	NOSE WIDTH MM	TAIL WIDTH MM	WAIST WIDTH MM	SIDE CUT RADIUS MM	STANCE WIDTH CM	SETBACK MM
149	1090	287.6	287.6	250	5.6	540	20
152	1110	291.6	291.6	252	5.6	540	20
155	1140	295.6	295.6	254	5.6	540	20

ALWAYS HAVE ALWAYS WILL

OUTSIDER PLUS

POPLAR AND BEECH ARE MIXED IN THE CORE MATERIAL, AND THE SHEET WOVEN WITH CARBON AND GRASS FIBER CREATE A FIRM BOARD TORSIONALLY. BUT ALLOWS FOR EXTRA STABILITY. THANKS TO THE HYBRID CAMBER. THIS BOARD HOLDS ITS LINE AND HAS EXCELLENT STRAIGHT RUNNING STABILITY. THIS BOARD IS BUILT FOR SPEED, AND ITS SENSE OF STABILITY WHEN IT COMES OUT THE FASTER YOU PUSH IT. BY PUTTING SMP(STABILIZER MESH POD) UNDER THE BINDING, THE BOARD IS RESPONSIVE TO YOUR MOVEMENTS AND IS RECOMMENDED FOR SNOWBOARDERS WHO ENJOY BIG KICKERS, HALF PIPES AND HIGH-SPEED CARVING THAT CAN REALLY CONTROL THE BOARD AND THE BOARD RESPONDS GREAT.



TOP

BASE

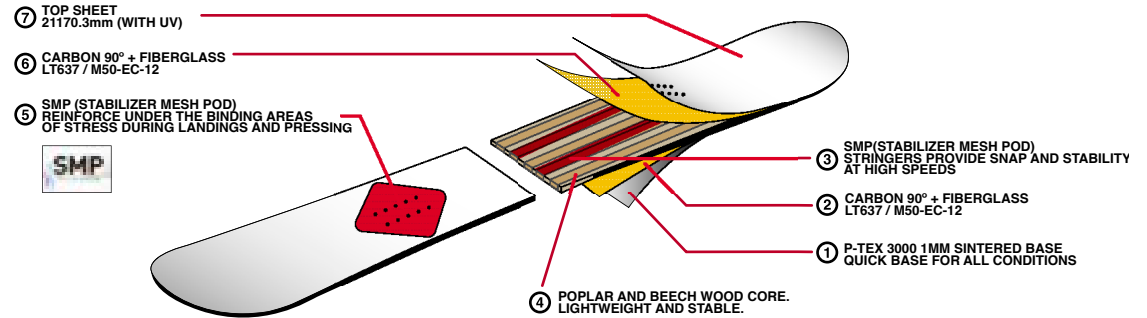

TWIN SHAPE:

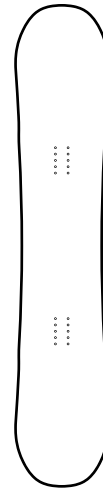

BASELINE:



FLEX



FREE RIDE



FREESTYLE



PARK / RAILS



HALF PIPE



DIMENSIONS

SIZE	EFFECTIVE EDGE CM	NOSE WIDTH MM	TAIL WIDTH MM	WAIST WIDTH MM	SIDE CUT RADIUS MM	STANCE WIDTH CM	SETBACK MM
148	1080	286.9	286.9	248	7.5	510	20
151	1110	290.8	290.8	250	7.5	540	20
154	1140	294.4	294.4	252	7.6	540	20

ALWAYS HAVE ALWAYS WILL

SELECT PLUS

A FULL LENGTH POPLAR CORE PROVIDES , WHILE A X SHAPE BASALT STRIP 4CM WIDE RUNNING OUT TO THE CONTACT ALLOWS FOR A NICE FLEXING BOARD, WITH A RIGHT AMOUNT OF TORSIONAL STIFFNESS IN THE CENTER WHERE THE STRIPS CROSS OVER. THE HYBRID CAMBER COMBINED WITH THE X SHAPE BASALT MAKES IT EASIER TO LEARN SPIN TRICKS, AND PRACTICE THEIR OLLIES AND RECOMMEND FOR BEGGINERS AS AN OVERALL EASY TO RIDER AND TURNING BOARD.

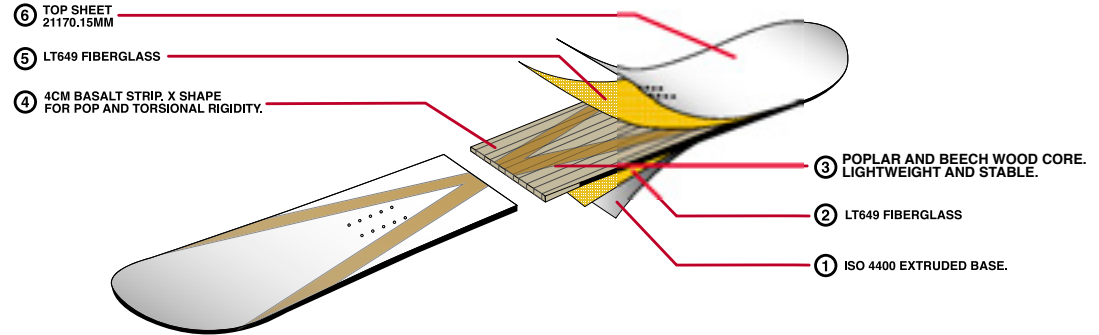

TWIN SHAPE:



BASELINE:



FLEX

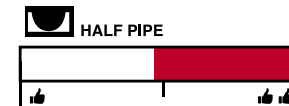
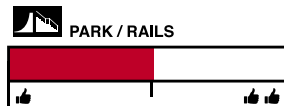
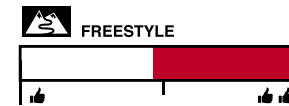
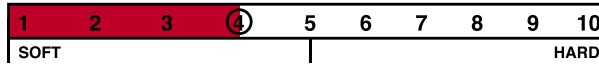

DIMENSIONS

SIZE	EFFECTIVE EDGE CM	NOSE WIDTH MM	TAIL WIDTH MM	WAIST WIDTH MM	SIDE CUT RADIUS MM	STANCE WIDTH CM	SETBACK MM
148	1080	286.9	286.9	248	7,5	510	20
151	1110	290.8	290.8	250	7,5	540	20
154	1140	294.4	294.4	252	7,6	540	20

ALWAYS HAVE ALWAYS WILL

AWESOME PLUS

UNLIKE THE CAMBER MODELS, THE INITIAL OPERATION OF THE TURN IS QUICK AND IT IS EASY TO SPIN, AND THE FLAT CAMBER DESIGNS MEANS DON'T HAVE TO FIGHT AS MUCH TO HOLD YOUR NOSE AND TAIL PRESSES. THANKS TO THE X-SHAPED CARBON IN THE NOSE AND TAIL, THERE IS FIRM POP, WHICH MAKES LAUNCHING OFF OF KICKERS ALL THE MORE FUN. CARBON PUT BETWEEN THE BINDINGS ADDS SOME TORSION STIFFNESS FOR EASY AND COMFORTABLE CARVING. SMP (STABILIZER MESH POD) IS USED UNDER THE BINDING AREA TO HELP STRENGTHEN THE BOARD ON THOSE STRESS AREAS IN LANDINGS AND DURING PRESS. THE FLAT CAMBER IS AN ALL-ROUND BOARD FOR INTERMEDIATE TO ADVANCED RIDERS WHO WANT TO ENJOY FREE RIDING WHILE STILL HITTING UP THE PARK, SOME GROUND TRICKS THROWN IN HERE AND THERE.

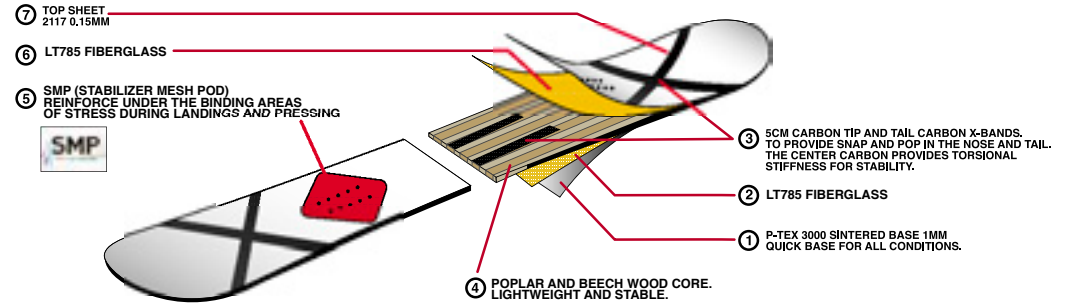

TWIN SHAPE:



BASELINE:



FLEX

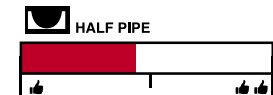
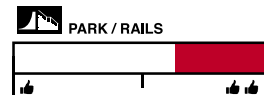
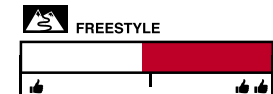

DIMENSIONS

SIZE	EFFECTIVE EDGE CM	NOSE WIDTH MM	TAIL WIDTH MM	WAIST WIDTH MM	SIDE CUT RADIUS MM	STANCE WIDTH CM	SETBACK MM
142	1040	277	277	230	6.3	450	0
147	1090	293.4	293.4	250	6.8	510	0
150	1120	296.1	296.1	252	7	540	0
153	1150	298.9	298.9	254	7.3	540	0
156	1180	301.7	301.7	256	7.5	540	0

ALWAYS HAVE ALWAYS WILL

RIOT PLUS

A SOFT FLEX CENTER MAKES IT EASY TO PULL UP THE NOSE AND TAIL, WHILE A CARBON STRIP IS VERTICALLY PLACED IN THE CENTER FROM TIP TO TAIL, CREATING A STRONG SNAP FOR OLLIES AND NOLLIES, CREATING HIGHER OLLIES FOR THAN TRADITIONAL BOARDS. STABLE AT ALL SPEEDS DUE TO A SOFTER CENTER, BUT STIFFER NOSE AND TAIL, MEANS YOU JUST POINT IT AND GO. IN ADDITION, SETTING A WIDE CENTER WIDTH FACILITATES JIB TRICKS AND FACILITATES STABLE LANDING WITHOUT ASKING SNOW QUESTIONS. THE COMBINATION OF POPLAR AND BEECH AS THE CORE MATERIAL, MAKES THIS BOARD LIGHTWEIGHT, AND POPPY.

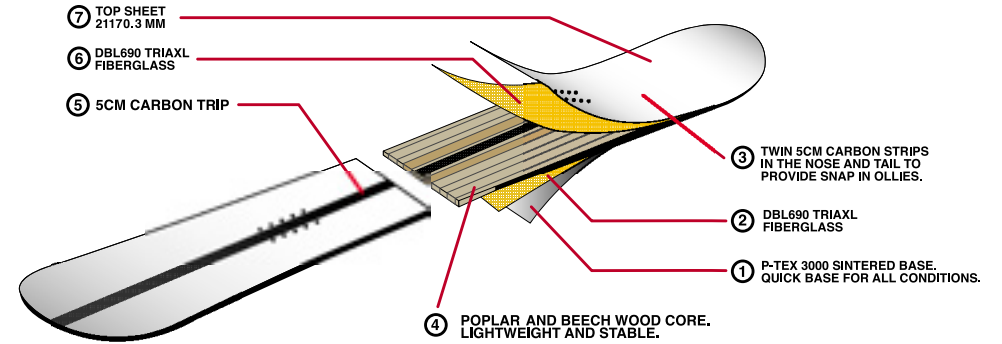

TWIN SHAPE:



BASELINE:



FLEX

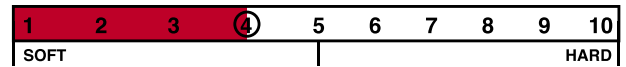

FREE RIDE



FREESTYLE



PARK / RAILS



HALF PIPE



DIMENSIONS

SIZE	EFFECTIVE EDGE CM	NOSE WIDTH MM	TAIL WIDTH MM	WAIST WIDTH MM	SIDE CUT RADIUS MM	STANCE WIDTH CM	SETBACK MM
138	980	276	276	235	6.2	450	0
147	1070	294.4	294.4	252	7.1	510	0
151	1110	297.4	297.4	254	7.4	540	0
155	1150	300.6	300.6	256	7.8	540	0

ALWAYS HAVE ALWAYS WILL

ADDICT PLUS

THE HYBRID DOUBLE CAMBER MAKES THIS BOARD FORGIVING ON TURNS, WHILE THE SOLID POPLAR CORE IS LIGHTWEIGHT, AND HAS NICE SOLID FEELING. A SOFTER TORSIONAL CENTER FLEX MAKES IT FOR BEGINNER'S TO LEARN HOW TO CONTROL THEIR BOARD FOR GROUND TRICKS, WHILE THE BASALT X BANDS IN NOSE AND TAIL PROVIDE SOME POP IN NOSE AND TAIL PRESSES. RECOMMENDED FOR ENTRY LEVEL USERS WHO WANT TO FOCUS ON GROUND TRICKS, OR THOSE WHO SNOWBOARDED IN THE PAST AND LOOKING TO COME BACK WITH A PLAYFUL FREESTYLE BOARD.

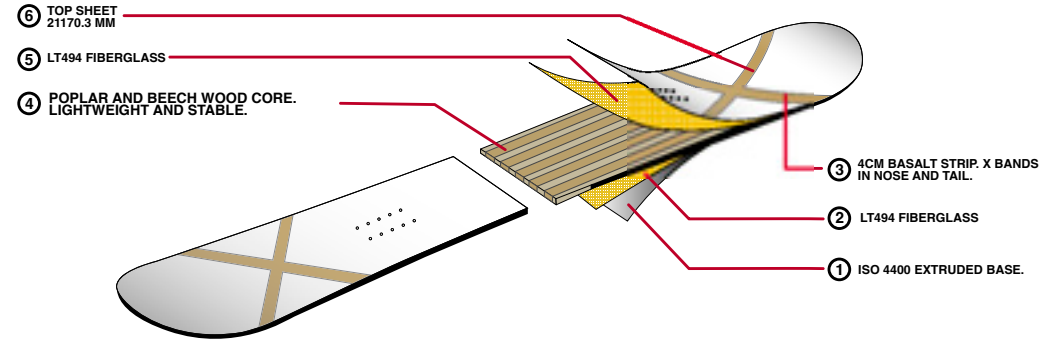
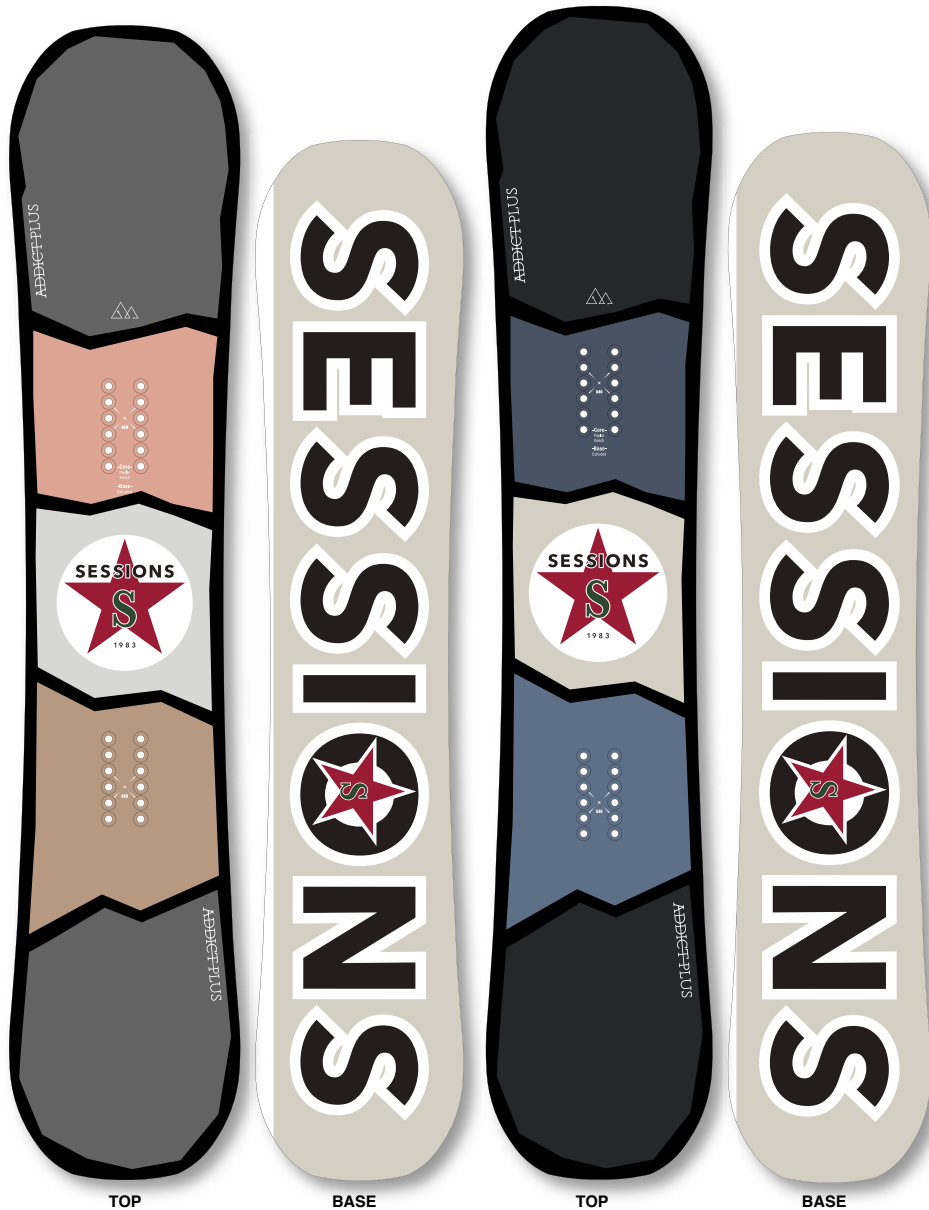

TWIN SHAPE:

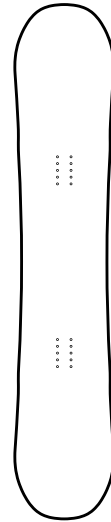

BASELINE:



FLEX

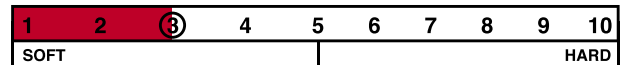

FREE RIDE



FREESTYLE



PARK / RAILS

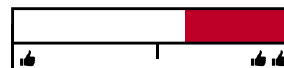

HALF PIPE



DIMENSIONS

SIZE	EFFECTIVE EDGE CM	NOSE WIDTH MM	TAIL WIDTH MM	WAIST WIDTH MM	SIDE CUT RADIUS MM	STANCE WIDTH CM	SETBACK MM
138	1000	286.2	286.2	242	6.6	460	0
144	1040	288	288	246	6.9	460	0
148	1080	289.6	289.6	248	7	540	0
151	1110	291.5	291.5	249	7.2	540	0
154	1140	295.1	295.1	252	7.4	540	0

ALWAYS HAVE ALWAYS WILL

SESSIONS

JAPAN

MANEUVERLINE
3-8-2 MIYOSHI KOTOKU
TOKYO 1350022
PHONE: 03-5245-3113

NORTH AMERICA

SESSIONS HEADQUARTERS
106 W 4TH ST. SUITE 500
SANTA ANA, CA 92701

@sessionsmfg
sessionsmfg.com